

FENIX2

Monitoring system



FIRE SAFETY

FENIX



Commissioning instruction

07/11/2023



FENIX

Contents

General	2
Products	3
1. Installation	3
2. Connection	4
3. Commissioning	6
Functions	9
Management and service	10

General

Control unit FENIX2 contains electronic components that can be damaged if used incorrectly. When connecting dampers, smoke detectors and other connections, the unit must be powered down!

The cover to access the terminal blocks is removed by unscrewing the cover on the lower part of the control unit. The connection terminals for 230 V AC are opened by inserting a screwdriver with a suitable width into the notch above the connector and then bend the screwdriver slightly upwards.



Products

System structure

FENIX2

FENIX2 is a control unit with connections for 1-2 fire dampers and smoke detector circuits that are automatically detected during commissioning.



FENIX 0-10 V module

When using regulating fire dampers, regulation can be performed in two different ways, either via a local 0-10 V signal out at the damper or via master communication (Modbus TCP or BACnet IP). If local control is desired with 0-10 V, the FENIX 0-10 V module is used to separate the local control signal, from, e.g. a room sensor, and the 10 V signal from FENIX2 that takes over during a functional test to check that the dampers can open.



1. Installation

Install FENIX2 with the requisite fasteners. A wall mount frame is fitted on the units at the factory and should be used to maintain the IP65 enclosure class.

The FENIX 0-10 V module is mounted on a wall or cable ladder. Power supply cables and end position indication from the damper motor are connected directly to the damper module. The FENIX 0-10 module in turn is connected directly to FENIX2.



2. Connection

Connect dampers, smoke detectors and other connections according to the following connection instructions when the unit is powered down.

NOTE! If a smoke detector is not connected, then noterminating resistance should **be fitted.**

The connection instructions for the ON/OFF damper (open/closed) are different from the regulating 0-10 V damper, see the connection instructions.

FENIX2

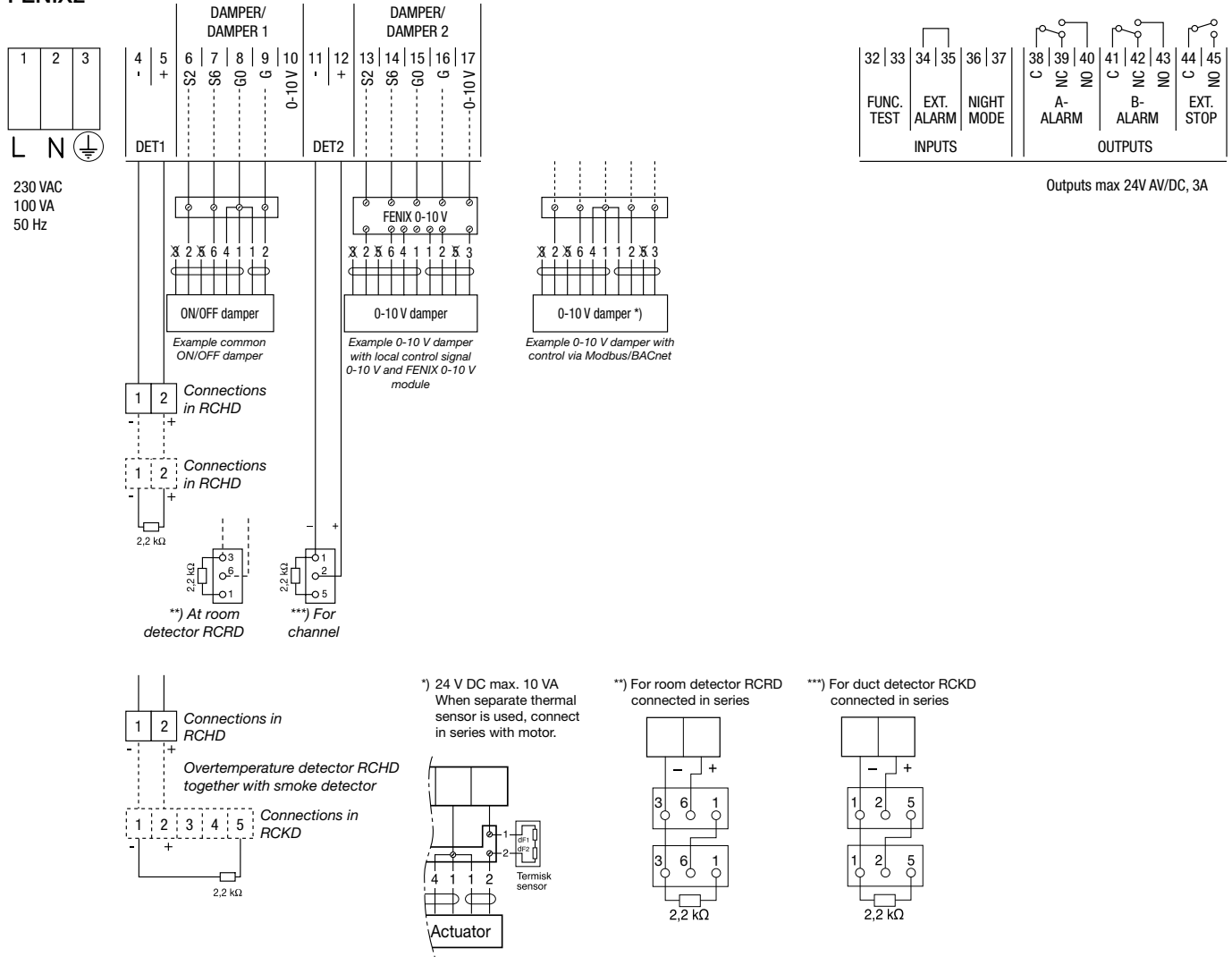

Cable recommendations

ON/OFF dampers, e.g. BSKC6 = EKKR/ELQRB/EQQRB 4x1 mm²

Regulating damper 0-10 V, e.g. BSKC6R = EKKR/ELQRB/EQQRB 5x1 mm² (7x1 mm²)

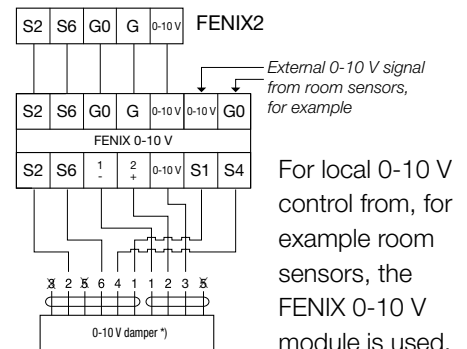



2. Connection cont.

Connection terminals	Function	Description
4+5, 11+12	Connection of smoke detector circuits	Each smoke detector circuit should have a 2.2 kOhm's resistance mounted at the end of the circuit, see the wiring diagram. The terminating resistance of 2.2 kOhm is connected to the last detector in each circuit. If a central fire alarm and/or no smoke detectors are used, a resistance of 2.2 kOhm should not be installed on these terminals. Max 24 V DC 90 mA.
6-10, 13-17	Connection of fire damper	For standard ON/OFF dampers, the input is not used for 10 V, this is done only for regulating dampers, see wiring diagrams. The damper output on G and G0 is 24 V DC, max 10 VA per output. Note! Only 1 fire damper per output!
Inputs	Function	Description
32+33	External function test/resetting External alarm	In the event of a short circuit, the controller performs a functional test and may reset the external incoming alarm, provided that terminals 34+35 do not have an open circuit. These terminals cannot be jumpered for automatic resetting. Instead, see options under settings.
34+35	External incoming alarm	In the event of an open circuit between terminals, External incoming alarm is activated, jumpered on delivery and if External incoming alarm is not used.
36+37	Night mode	In the event of short circuiting of the terminals, the panel enters Night mode whereby all dampers close without the controller generating alarms. Used, for example, during intermittent operation. Night mode can also be a good safety measure for preventing the spread of combustion gases when the ventilation is switched off, duct-mounted smoke detectors do not have the same opportunity to detect smoke when no air is transported in the system.
Outputs	Function	Description
38+39+40	Main alarm (A-alarm on circuit board)	Potential-free changeover contact that switches for: • Detector failure • Damper failure • Tripped detector • External incoming alarm • Power outage • System failure • Communication failure with slave units • Internal battery needs to be replaced In normal operation, terminals 38+40 have contact. Drawn in de-energised/alarm mode. Max 24 V AC/DC, 3 A
41+42+43	Service alarm detector circuits (B-alarm on circuit board)	Potential-free changeover contact that switches for soiled detector. In normal operation, terminals 41+43 have contact. Drawn in de-energised/alarm mode. Max 24 V AC/DC, 3 A
44+45	External stop of fan/unit	Breaking potential-free contact that breaks for: • Functional testing of fire dampers • Main alarm In normal operation, terminals 44+45 have contact. Drawn in de-energised/alarm mode. Max 24 V AC/DC, 3 A
	Network connection	Cable connection RJ45, 10Base-T/100Base-TX auto-negotiation Cable length Max. 100 m Cabling Min. Cat 5

- Measure the voltage with a multimeter use a well-known brand.
- Check cables using an Ohmmeter with all devices disconnected.
- Never use a megohmmeter!
- All cable connections and disconnections are done with the FENIX2 powered down.



3. Commissioning

1. Power the unit with 230 V AC
2. Press START on the display and follow the commissioning instructions below.

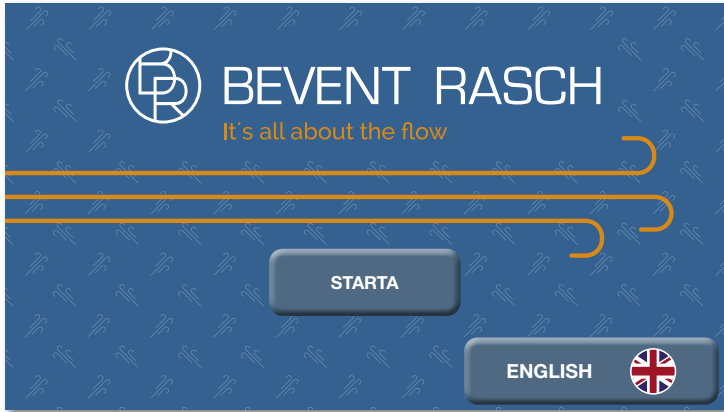

The start page when powered up.

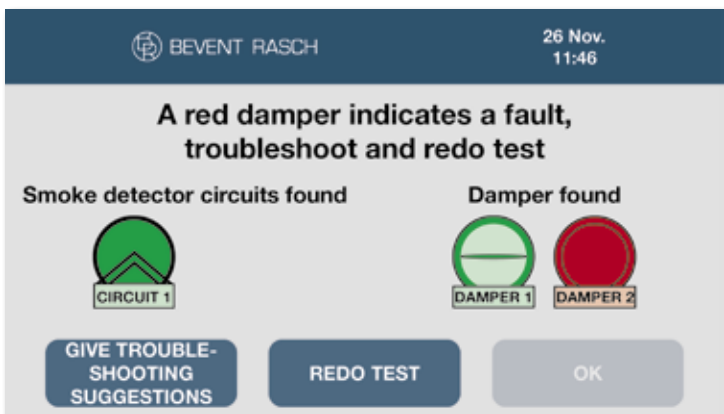

Example system with 1 smoke detector circuit and 2 fire dampers with a faulty or broken damper.

If a fire damper is connected incorrectly or does not work, a red icon will appear.

For safety reasons, a faulty system cannot be started. Use the troubleshooting guide on the display to correct the fault before commissioning.

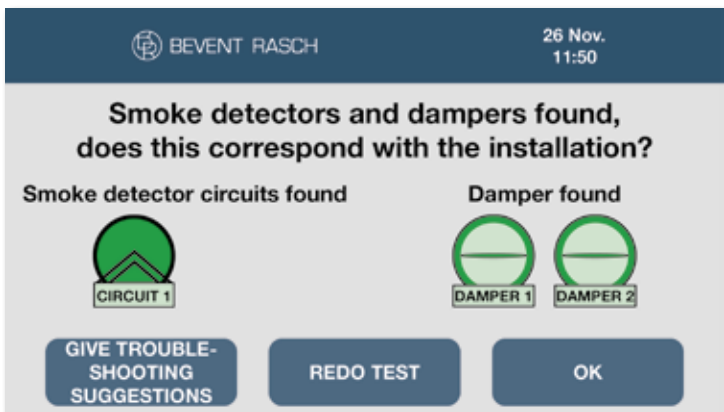

Example system with 1 smoke detector circuit and 2 fire dampers.

Check that the number of fire dampers and smoke detector circuits found match the installation.

Use the troubleshooting guide on the display if your dampers or smoke detector circuits are not displayed.

NB: The icons also show whether the dampers are of ON/OFF type or regulating 0-10 V.



Symbol descriptions

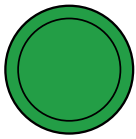

Closed damper

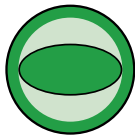

Damper in middle position

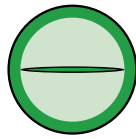

Open damper



"DAMPER 1"
Indicates which damper on the unit
FENIX4 / FENIX+

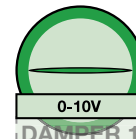

"0-10 V"
Indicates whether the damper is regulating:
0-10 V = regulating
No box = On/Off

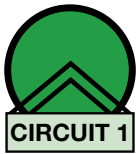

Green
= All OK

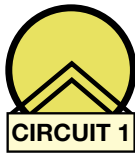

Yellow
= Service

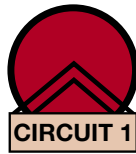

Red
= Error / Alarm

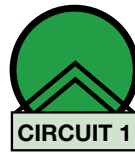

"CIRCUIT 1"
Indicates which detector circuit on the unit
FENIX4 / FENIX+

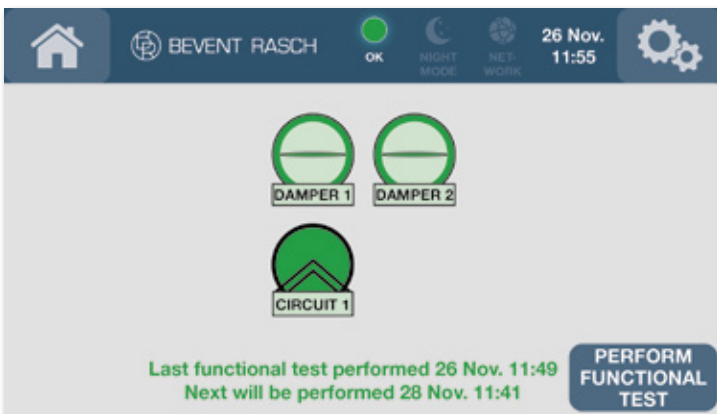

Example system with 1 smoke detector circuit and 2 fire dampers after correct commissioning.

After an approved functional test has been carried out, FENIX2 is part of the fire protection.



Function description

Functions and settings via the display

Date and Time

The date and time are set from the factory, but can be easily changed on-site if necessary. The unit is equipped with automatic summer and winter time adjustment.

Language

Easily choose between Swedish and English.

Time of functional testing

Easily set the interval when functional testing of the fire dampers is performed and when during the day to do it. Selectable ranges:

- 1 time every 24 hours
- 1 time every 48 hours
(recommended and default setting on delivery)
- 1 time per week
- 1 time per month
- 1 time every 6 months

Perform functional testing

If necessary, you can easily perform a functional test via the display on FENIX2. Can also be performed by shorting terminals 32 and 33.

Device information and communication settings

Simply set the desired communication settings for Modbus TCP or BACnet IP via the display.

IP address is assigned automatically via Dynamic Host Configuration Protocol (DHCP). If a fixed IP address is desired, this can be configured via the settings in the touch display.

Delay External stop

If desired, functional testing of fire dampers can be delayed by 5 minutes. Relay "EXT. STOP" between terminals 44 and 45 then breaks directly for internal functional testing, the functional test of the dampers is performed first after a 5 minute delay, which then allows the electric heating coils to cool down.

Default setting: no delay.

Automatic reset of External incoming alarm

Normally an External incoming alarm (34 + 35) needs to be acknowledged on the unit via the display or terminal block 32 + 33 (default setting), this function permits External incoming alarms to be acknowledged automatically when a possible external alarm stops. Default setting: no automatic reset.

System reset

The system is easily reset to the default settings when necessary.

Automatic functions integrated in FENIX2

Dynamic troubleshooting diagrams

Instead of the traditional troubleshooting documents that previously accompanied older controllers, FENIX2 shows exactly what fault occurred and proposed actions directly on the display, such as if a damper does not make contact with the limit switch for the closed position:

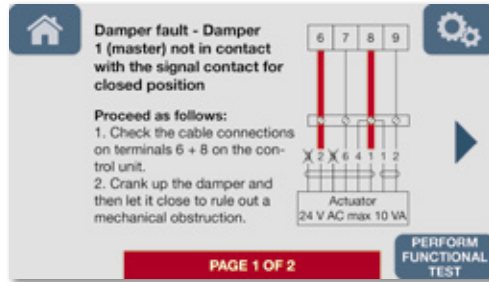

The unit then shows exactly what damper fault has been identified, which connection terminals and cables should be checked and troubleshot. This function facilitates any service and troubleshooting in the event of a fault during the lifespan of the property. The same pedagogical approach applies to smoke detector circuits, external alarms and other functions that trigger something in the controller.

Dynamic trouble shooting diagrams and associated action texts play an important role in the simplicity of FENIX2.

Automatic functional testing

All connected fire dampers are automatically functionally tested. In order to ensure that regulating dampers work at all damper angles, check the limit switches for both the open and closed positions for all connected dampers.



Management and service

The FENIX2 system is designed to facilitate management and service by presenting troubleshooting suggestions and measures for each specific service issue. This means that you do not have to keep any troubleshooting manuals and other documentation.

The unit will alert when the internal battery needs to be replaced. This can also be done in connection with service or an obligatory ventilation control (OVK).

Instructions for replacing the battery

1. Power down the unit, no 230 V AC must be connected when replacing the battery.
2. Remove the cover by loosening the screws as shown below.

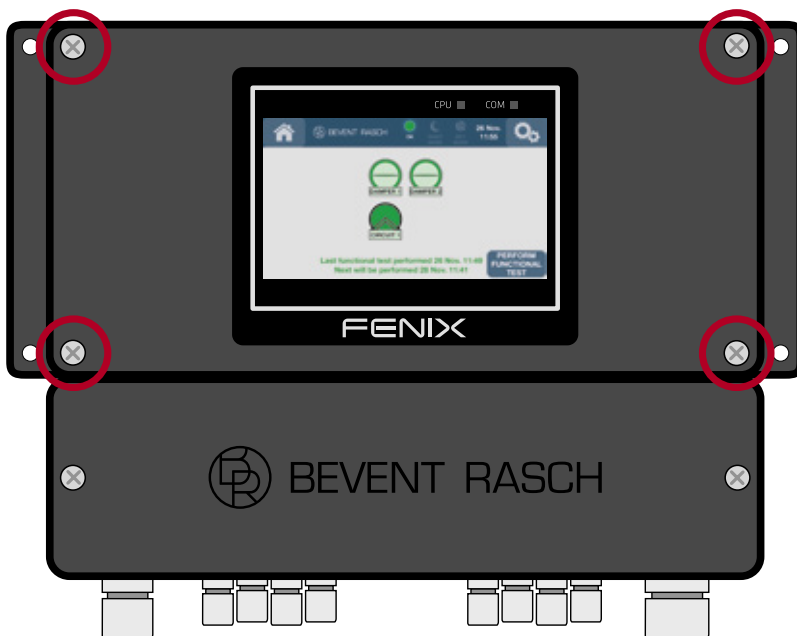

3. Replace the CR2032 battery on the right side of the PCB.

Replace the battery within 10 seconds to prevent the unit from losing its settings. If the unit is left without a battery connected for more than 10 seconds, any settings must be made again.

4. Refit the front by screwing on the cover again.
5. The unit automatically restarts with retained settings.